



# JSP-200

## Sample Gas Pump with Bypass Valve



Handling | Installation | Maintenance

# MANUAL

# Contents

1 Introduction.....	2
1.1 Intended use .....	2
1.2 Scope of delivery .....	3
1.3 Product description .....	3
2 Safety instructions.....	4
2.1 Important advice .....	4
2.2 General indication of risk .....	4
3 Transport and storage .....	6
4 Installation and connection .....	7
4.1 Requirements for the set-up location .....	7
4.1.1 Outdoor installation.....	7
4.2 Mounting.....	8
4.3 Special condition moist sample gas .....	8
4.3.1 Alteration of hanging pump bodies .....	9
4.4 Connecting the sample gas line.....	9
4.5 Electrical connections .....	10
5 Operation and control .....	11
5.1 Switching on the sample gas pump .....	11
5.2 Operating the sample gas pump.....	12
6 Maintenance.....	13
6.1 Replacing the inlet and outlet valves .....	14
6.2 Replacing bellow and connecting rod-eccentric-combination.....	14
6.3 Replacement of the O-ring of the bypass valve (optional).....	15
6.4 Changing the Coupling.....	15
7 Service and repair.....	16
7.1 Troubleshooting and fault rectification.....	17
7.2 Spare parts and accessories .....	19
8 Disposal.....	18
9 Appendices.....	19
9.1 General specifications for all pumps.....	20
9.2 Feed Curves .....	20
9.3 Technical data .....	20
9.4 Dimensions .....	21
9.5 Oder Codes .....	22
10 Attached documents .....	23

# 1 Introduction

## 1.1 Intended use

Sample gas pumps are intended for installation in gas analysis systems for industrial applications.

The sample gas pump is only intended to convey gaseous media. It is not suitable for liquids.

Please note the additional information in chapters "Product Description" and "Operation and Control" along with the information on specific intended use, existing material combinations, as well as pressure and temperature limits in the data sheets.

**DANGER****Potentially explosive atmosphere**

Explosion hazard if used in hazardous areas.

The device is not suitable for operation in hazardous areas with potentially explosive atmospheres.

Do not expose the device to combustible or explosive gas mixtures.

When installed outdoors, ensure adequate protection from the weather, see chapter Requirements for the set-up location [> page 8]

## 1.2 Scope of delivery

### JSP-200

---

1 x Sample gas pump with motor  
4 x Rubber-metal bumpers  
1 x Mounting bracket  
Product documentation

## 1.3 Product description

The sample gas pumps are only intended to convey gaseous media. They are not suitable for liquids.

Please note the specifications in the appendix to this manual on the specific intended use, existing material combinations, as well as pressure and temperature limits. In addition, please also note the specifications and markings on the nameplates.

## 2 Safety instructions

### 2.1 Important advice

Operation of the device is only permitted if:

- the product is used under the conditions described in the installation- and operation instruction, the intended application according to the type plate and the intended use. In case of unauthorized modifications done by the user JCT Analysentechnik GmbH can not be held responsible for any damage
- when complying with the specifications and markings on the nameplates.
- the performance limits given in the datasheets and in the installation- and operation instruction are obeyed,
- monitoring devices and safety devices are installed properly,
- service and repair is carried out by JCT Analysentechnik GmbH,
- only original spare parts are used.











This manual is part of the equipment. The manufacturer keeps the right to modify specifications without advanced notice. Keep this manual for later use.

### Signal words for warnings

- DANGER** Signal word for an imminent danger with high risk, resulting in severe injuries or death if not avoided.
- WARNING** Signal word for a hazardous situation with medium risk, possibly resulting in severe injuries or death if not avoided.
- CAUTION** Signal word for a hazardous situation with low risk, resulting in damaged to the device or the property or minor or medium injuries if not avoided.
- NOTICE** Signal word for important information to the product.

### Warning signs

In this manual, the following warning signs are used:

	Warning against hazardous situations		General notice
	Warning against electrical voltage		Disconnect from mains
	Warning against respiration of toxic gases		Wear respirator
	Warning against acid and corrosive substances		Wear eye/face protection
	Warning against potentially explosive atmospheres		Wear protection gloves
	Warning against hot surface		

### 2.2 General indication of risk

The equipment must be installed by a professional familiar with the safety requirements and risks. Be sure to observe the safety regulations and generally applicable rules of technology relevant for the installation site. Prevent malfunctions and avoid personal injuries and property damage.

**The operator of the system must ensure:**

- Safety notices and operating instructions are available and observed.
- The respective national accident prevention regulations are observed.
- The permissible data and operational conditions are maintained.
- Safety guards are used and mandatory maintenance is performed.
- Legal regulations are observed during disposal.
- Compliance with national installation regulations.

**Maintenance, Repair**

Please note during maintenance and repairs:

- Repairs to the unit must be performed by JCT Analysentechnik GmbH authorised personnel.
- Only perform conversion-, maintenance or installation work described in these operating and installation instructions.
- Always use genuine spare parts.
- Do not install damaged or defective spare part. If necessary, visually inspect prior to installation to determine obvious damage to the spare parts.

Always observe the applicable safety and operating regulations in the respective country of use when performing any type of maintenance.

**DANGER****Electrical voltage**

Electrocution hazard.

- Disconnect the device from power supply.
- Make sure that the equipment cannot be reconnected to mains unintentionally.
- The device must be opened by trained staff only.
- Regard correct mains voltage.

**DANGER****Toxic, corrosive gases**

The measuring gas led through the equipment can be hazardous when breathing or touching it.

- Check tightness of the measuring system before putting it into operation.
- Take care that harmful gases are exhausted to a safe place.
- Before maintenance turn off the gas supply and make sure that it cannot be turned on unintentionally.
- Protect yourself during maintenance against toxic / corrosive gases. Use suitable protective equipment.

**DANGER****Potentially explosive atmosphere**

Explosion hazard if used in hazardous areas.

The device is not suitable for operation in hazardous areas with potentially explosive atmospheres. Do not expose the device to combustible or explosive gas mixtures.

**CAUTION****Tipping hazard**

Equipment damage.

Secure the device against tipping, sliding and falling.

**CAUTION****Hot surface**

Burning hazard

According to the product type and operation conditions, the temperature may exceed 50 °C during operation.

Depending on the conditions at the installation site it may be necessary to provide these areas with appropriate warning signs.

### 3 Transport and storage

Only transport the product inside the original packaging or a suitable alternative.

The equipment must be protected from moisture and heat when not in use. They must be stored in a covered, dry and dust-free room at a temperature between -20 °C to +40 °C (-4 °F to 104 °F). To avoid bearing damage, ensure a vibration-free environment ( $v_{eff} < 0.2$  mm/s).

Outdoor storage is prohibited. On principle the operator must meet all applicable standards with respect to preventing damage due to lightning, which could result in sample gas pump damage.

Storage areas must not contain any equipment generating ozone, e.g. fluorescent lighting, mercury vapour lamps, high voltage electrical equipment.

After prolonged storage or downtimes test the insulation resistance of the winding, phase against phase and phase against mass, prior to initial operation. Moist windings can cause current leaks, flashovers and breakdown. The insulation resistance of the stator winding must be at least 1.5 M $\Omega$  measured at a winding temperature of 20 °C (68 °F). Values below this require drying the winding.

The motor shaft should be turned occasionally to ensure the entire bearing remains lubricated. To do so, remove the three cross-tip screws (9) of the console cover (8) and remove. This exposes the crank gear (10). You can now turn the motor shaft on it.

**For the item numbers, please refer to the assembly drawing 42/025-Z02-01-2 in the appendix.**

#### CAUTION

#### Contusion hazard



Contusion of the fingers!  
Don't have your fingers caught between eccentric and slide.

## 4 Installation and connection

Check the equipment for damage before installation. Among other things, this could be a damaged housing, supply cables, etc. Never use equipment with obvious damage.

### 4.1 Requirements to the installation site

#### CAUTION



#### Equipment damage

Protect the equipment, particularly gas connections and gas lines, from dust, falling objects, as well as external blows.

#### Lightning

On principle, the operator must meet all applicable standards with respect to preventing damage to the equipment due to lightning, which could result in equipment damage.

Never block the vent, and the exhaust air – including from adjacent units – must not be immediately suctioned in. When installing without JCT mounting bracket, be sure the motor is far enough from the back panel (at least 40 mm). The sample gas pumps are rated for altitudes  $\leq 1,000$  m. They're available in various styles and the specific technical data may vary. Therefore always note all device-specific data on the pump and motor type plate and their specific limits - see Technical Data.

#### 4.1.1 Outdoor Installation

The sample gas pumps were not specifically designed for outdoor setup.

The operating and environmental conditions are crucial for the required types of protection and any additional measures required, such as:

- adequate protection from the weather
- Adjusting the maintenance intervals (e.g. cleaning and replacing wear parts)

Use suitable measures and regular inspections to prevent damage to the equipment from e.g.:

- Corrosion
- Sunlight (temperature peaks and damage from UV rays)
- Moisture from condensation (e.g. due to rapid temperature changes or downtimes)
- Icing
- Insects and microbes
- other animals, e.g. martens, etc.

Please remember that all technical operating parameters of the equipment must also be met with outdoor installation.

Specifically:

- Maximum or minimum operating temperatures
- Degree of protection



## 4.2 Mounting

**CAUTION****Damage to the device**

Protect the device, especially the gas inlets and tubes, against dust, falling parts and external impact.

When installing the JSP-200 on mounting plates, use the included mounting bracket and only the included rubber/metal bumpers. Operation without rubber/metal bumpers is prohibited. These must also be used when installing the pump on an existing substructure. For the hole pattern in the mounting bracket and the motor foot, please refer to the Technical Data at the end of the operating and installation instructions.

## 4.3 Special condition moist sample gas

Applications where the sample gas is still moist may result in condensate forming in line and the pump body. In these events the pump head must be suspended (pump body facing down).

If the pump was not ordered this way, it can easily be converted on site.

Install the line between the gas output and condensate drain with a grade so the condensate can drain and does not collect inside the pump or the lines.

### 4.3.1 Alteration of hanging pump bodies

**CAUTION**

**Damage to the device**

Especially with pump head pointing down, make sure that no dust or small parts can intrude the pump through the ventilations slot. Nevertheless, the slot must not be covered directly.

If this is not possible, the pump must not be mounted with pump head pointing downward.

**Please refer to assembly drawing 42/025-Z02-01-2 in the appendix for the conversion.**

- Remove the three cross-tip screws (9) and remove the console cover (8) from the pump console (5). This exposes the crank gear (10) and the motor flange or, depending on pump model, the intermediate flange.
- The Pump console attaches to the flange with four hexagon screws (7) and lock washers (6). Completely unscrew these, holding the pump console, and rotate it 180° on the centring of the flange.
- Reinstall all parts in the reverse order. Please note the torque of the hexagon screws (7) is 3 Nm.  
Installing the pump head offset by 45° or 90° is prohibited!

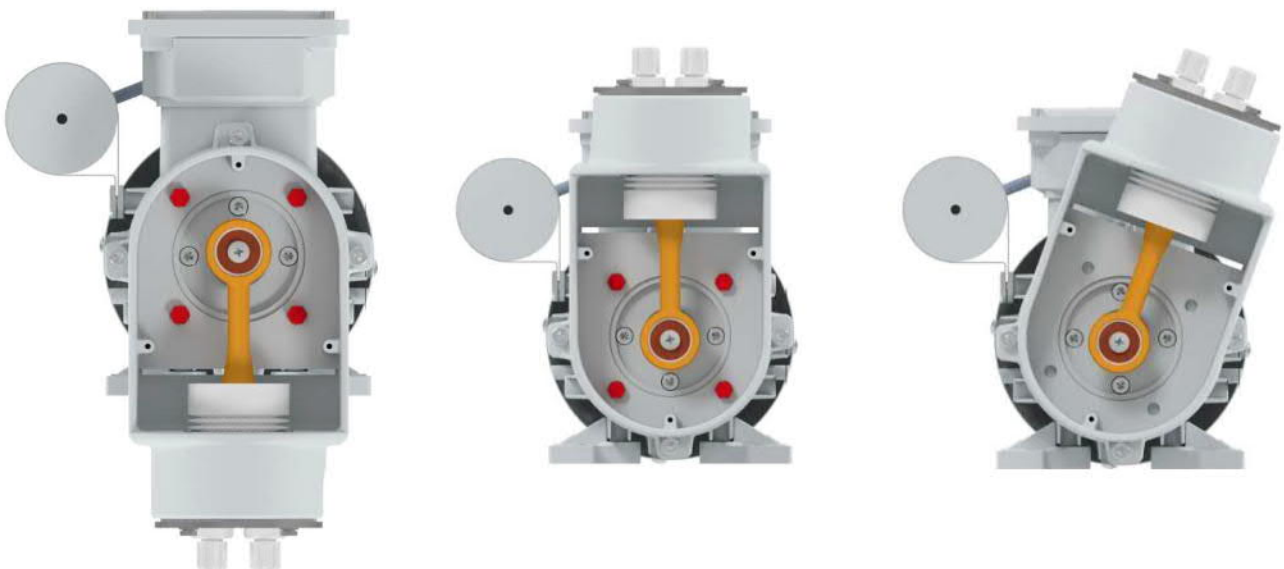

### 4.4 Connecting the sample gas line

The pumps are delivered with customized gas connections. Please compare the part-no. on the type plate with the part no. explained in chapter "Introduction". Avoid mixed installations, that is connecting metal tubes to plastic bodies. If this is unavoidable for sporadic applications, screw the metal fitting with utmost care and without any use of force to the PTFE pump body. Install the tubes in a way that the line at the inlet and outlet is flexible over a sufficient distance (pump vibrates). The pumps are marked with "In" for inlet (input) and "Out" for outlet (output). Make sure that the connections to the tubes are tight.

## 4.5 Electrical connections

**WARNING**

**Hazardous electrical voltage**



The device must be installed by trained staff only.

**CAUTION**

**Wrong mains voltage**



Wrong mains voltage may damage the device.  
Regard the correct mains voltage as given on the type plate.

A switch or circuit breaker (according to IEC 60947-1 and IEC 60947-3) must be installed for the sample gas pump. It must be easy for the operator to reach. The switch must be marked as a cut-off for the device. It mustn't be integrated into a supply cable or interrupt the earth conductor. It must further separate all poles of the sample gas pump from live parts.

The sample gas pump must be protected against prohibited heating with suitable overload protection (protective motor switch).

Please note the rated current for the protective switch settings (see motor type plate).

Verify the pump motor has the correct voltage and frequency: Voltage tolerance  $\pm 5\%$ , frequency tolerance  $\pm 1\%$  from rated value.

Properly connect the sample gas pump per the respective wiring diagram (see below). If the wiring diagram inside the cover of the terminal box is different, observe that instead. The required tightening torque for the nuts on the terminal board is 1.5 Nm. Ensure the connecting cable has adequate cable relief. The clamping area of the cable gland is 6-10 mm. The required tightening torque for the cable gland is 5 Nm.

The supply line and earthing cross-sections must be aligned with the rated current. Use a minimum line cross-section of 1.5 mm<sup>2</sup>.

Be sure to connect the following protective earth terminals to your on-site earth conductor per local regulations:

- Protective earth terminal inside the motor terminal box.
- Protective earth terminal on the mounting bracket.

Stray electric currents may not flow through this connection.

No foreign objects, contaminants or moisture may be inside the junction box. Any unused cable gland openings must be sealed with plugs approved for the application (if necessary ATEX, IECEx).

To maintain the IP rating specified by the manufacturer, when sealing the terminal box with the cover ensure the original seal is correctly seated and appropriately tighten the bolts.

Be sure to observe any varying information in the rating plate. The conditions at the site must correspond with all rating plate information.

**Three-phase motors**

Delta connection  
lower voltage

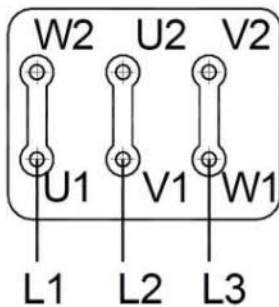

**Three-phase motors**

Star connection  
higher voltage

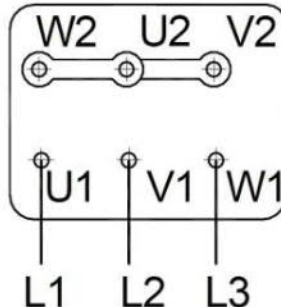

**AC motors with operating capacitor**

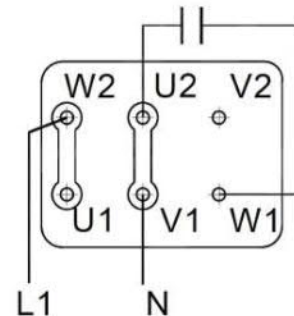

## 5 Operation and control

### NOTICE



The device must not be operated beyond its specifications.

### CAUTION



#### Hot surface

Burning hazard

According to the product type and operation conditions, the temperature of the housing may exceed 50°C during operation. Depending on the conditions at the installation site it may be necessary to provide these areas with appropriate warning signs.

### DANGER



#### Toxic, corrosive gases

The measuring gas led through the equipment can be hazardous when breathing or touching it.

- Check tightness of the measuring system before putting it into operation.
- Take care that harmful gases are exhausted to a safe place.
- Before maintenance turn off the gas supply and make sure that it cannot be turned on unintentionally.
- Protect yourself during maintenance against toxic / corrosive gases. Use suitable protective equipment.



### 5.1 Switching on the sample gas pump

#### Before switching on the device, ensure that:

- the hose and electrical connections are undamaged and correctly installed,
- no parts of the sample gas pump have been dismantled (e.g. cover),
- the gas inlet and outlet of the sample gas pump is not shut,
- the preliminary pressure is under 0.5 bar,
- in the event of throttling under 150 l/h or under 400 l/h in continuous operation, a bypass is available,
- the ambient parameters are complied with,
- information on rating plates is observed,
- the voltage and frequency of the motor correspond to those of the network,
- the electrical connections are tightly fastened and the monitoring devices have been connected and configured correctly!
- air inlet openings and cooling surfaces are clean,
- protective measures have been carried out; earthing!
- the motor is secured correctly,
- the terminal box cover is closed and the cable entry points have been properly sealed.

#### When switching the sample gas pump on make sure that

- no abnormal sounds or vibrations occur.
- the flow rate is neither too low nor too high. This would indicate a cracked bellow.

## 5.2 Operating the sample gas pump

The sample gas pump is intended exclusively for the pumping of gaseous media. It is not suitable for liquids.

The sample gas pump should be operated without pre-compression. A preliminary pressure of more than 0.5 bar is not permitted. The gas outlet must not be shut. The flow rate must be at least 50 l/h for the JSP-200 230 V and at least 200 l/h for the JSP-200 115 V pumps. In the event of throttling under 150 l/h for the 230 V version or under 400 l/h for the 115 V version pumps in continuous operation, the flow rate must be regulated via a bypass. In this case you should choose a version with bypass valve.

### NOTICE



Extreme throttling reduces the life time of the bellows.

The output can be adjusted on pumps with built-in bypass valve. Do not apply a lot of force when turning the valve as the valve could otherwise be damaged! The rotation range of the valve is about seven rotations.

## 6 Maintenance

The unit must be cool before performing maintenance.

During maintenance, remember:

- The equipment must be maintained by a professional familiar with the safety requirements and risks.
- Only perform maintenance work described in these operating and installation instructions.
- Observe the respective safety regulations and operating specifications when performing any type of maintenance.
- Always use genuine spare parts.

### NOTICE



Please refer to the assembly drawings in the appendix when carrying out maintenance.

### DANGER

#### Electrical voltage



Electrocution hazard.

- a) Disconnect the device from power supply.
- b) Make sure that the equipment cannot be reconnected to mains unintentionally.
- c) The device must be opened by trained staff only.
- d) Regard correct mains voltage.



### DANGER

#### Toxic, corrosive gases



The measuring gas led through the equipment can be hazardous when breathing or touching it.

- a) Check tightness of the measuring system before putting it into operation.
- b) Take care that harmful gases are exhausted to a safe place.
- c) Before maintenance turn off the gas supply and make sure that it cannot be turned on unintentionally.
- d) Protect yourself during maintenance against toxic / corrosive gases. Use suitable protective equipment.



### CAUTION

#### Tipping hazard



Equipment damage.

Secure the device against tipping, sliding and falling.

### CAUTION

#### Gas leakage



The sample gas pump should not be dismantled under pressure.

### CAUTION

#### Hot surface



Burning hazard

According to the product type and operation conditions, the temperature may exceed 50 °C during operation.

Depending on the conditions at the installation site it may be necessary to provide these areas with appropriate warning signs.

Depending on the quality of the sample gas being transported, you may need to occasionally replace the inlet and outlet valves. Instructions for replacing parts can be found in chapter Replacing the inlet and outlet valves [> page 16].

If the valves are very dirty, particularly after just a short time of operation, you should install a particle filter upstream from the pump. This will significantly increase the operating life.

After approx. 500 operating hours tighten the screws for the mounting ring to 3 Nm.

## 6.1 Replacing the Inlet and outlet valves

**Please refer to assembly drawing 42/025-Z02-01-2 in the appendix for this maintenance**

- Remove the screw-in connections (18) from the pump body (13).
  - Unscrew the valves (17) with a wide slot screwdriver. Stainless steel pump bodies have so-called displacers (20) under the valves. These reduce the dead volume and must remain installed on these pump bodies.
  - Screw the new valves into the pump body and tighten to max. 1 Nm. Be sure the valve is installed the correct direction. Valves for a permitted gas inlet temperature of max. 100 °C are black/red, and grey/orange for max. 160 °C. Here the red or orange end corresponds to the gas inlet and the black or grey end the gas outlet. The valves at the gas inlet are marked "EIN" and "IN" and "AUS" and "OUT" at the gas outlet. The marking you see looking into the pump body from above determines the valve function.
  - Reinstall the screw-in connections in the pump body. In case of stainless steel screw-in connections, replace any damaged seals (19).
  - Check the sample gas pump for leaks.
  - Perform a test run. At a minimum, the following values must be reached:  
Overpressure: 230 V = 1.7 bar; 115 V = 3.5 bar  
Negative pressure: 230 V = -0.65 bar; 115 V = -0.75 bar  
Flow rate: 230 V = 400 L/h; 115 V = 800 L/h
- Record the maintenance including test values in the „operating log (template)“ of the sample gas pump.

## 6.2 Replacing bellow and connecting rod-eccentric-combination

### NOTICE

#### Restrictions for connecting rod-eccentric replacement



The individual replacement of the eccentric, connecting rod or bearings is not allowed. Only the factory pre-assembled connecting rod-eccentric combination is suitable for replacement by the operator.

**Please refer to assembly drawing 42/025-Z02-01-2 in the appendix for this maintenance.**

1. Remove the three cross-tip screws (9) and remove the console cover (8) from the pump console (5)
2. Clean any dust and other dirt off the sample gas pump. Wipe off stubborn dirt with a damp, clean cloth (do not use cleaning products containing solvents).
3. Remove the 4 hexagon screws (16) and the spring washers (15) at the top of the pump body (13). PTFE pump bodies also have a mounting ring (14) installed for improved seating stress.
4. Carefully pull the pump body up and out of the pump console. Be careful not to overstretch the bellow (12). If the pump body is stuck to the bellow, try carefully turning it to release it.
5. Hold the bellow just above the follower (10) and unscrew it anti-clockwise. When only changing the bellow, skip to step 14.
6. Remove the 4 hexagon screws (7) and lock washers (6) and remove the pump console from the flange.
7. Loosen and remove the set screw (11) from the eccentric of the crank gear (10). This may either be hexagon socket (SW 2) or star drive (TX 8). Use the proper tool.
8. Now carefully remove the crank gear from the shaft. This is best done with 2 large slot screwdrivers.
9. Clean the shaft and if necessary remove any residue such as frictional corrosion, etc. Check the fit size of 11k6.
10. Dampen the shaft with resin-free oil prior to assembly.
11. Attach the new crank gear to the shaft and align the locking bore for the set screw with the corresponding bore in the shaft. Avoid using striking tools, as these may damage the ball bearings.
12. Insert the set screw with medium-strength threadlock and tighten to 1.5 Nm. Be sure the flat point of the set screw is properly seated in the bore on the shaft.
13. Now place the pump console over the crank gear again and either align it upward or rotated by 180° and secure with the hexagon screws (7) and lock washers (6) - tightening torque 3 Nm.
14. Check the sealing surface and the pleats of the bellow for damage and dirt.
15. Insert the bellow through the pump console from above and twist it clockwise onto the plunger of the crank gear hand tight.
16. Clean the pump body and check the sealing face for damage.
17. Attach the pump body to the bellow and turn into the desired position in relation to the gas inlet and outlet. On principle the alignment of the pump body is irrelevant. However, it's important to ensure the marking on the mounting ring or pump body matches the installed valve and its function. There is no difference between inlet valve and outlet valve. Their installation position determines the function. The valves are always labelled "EIN" or "IN" for inlet and "AUS" or "OUT" for outlet.

18. Reattach the pump body with the 4 hexagon screws (16) and spring washers (15) and in the case of PTFE bodies with the mounting ring, and tighten the bolts crosswise, first at 1 Nm, then 3 Nm.

19. Lastly, reattach the console cover with the 3 cross-tip screws.

20. Check the sample gas pump for leaks.

21. Perform a test run. At a minimum, the following values must be reached:

Overpressure: 230 V = 1.7 bar; 115 V = 3.5 bar

Negative pressure: 230 V = -0.65 bar; 115 V = -0.75 bar

Flow rate: 230 V = 400 L/h; 115 V = 800 L/h

Record the maintenance including test values in the „operating log (template)“ of the sample gas pump.

### 6.3 Replacement of the O-ring of the bypass valve (optional)

**Please refer to assembly drawing 42/025-Z02-01-2 in the appendix for this maintenance.**

– Loosen the two bolts (24) and carefully pull the entire unit, consisting of valve plate (23), spindle (22) and O-ring (21) on the knob (26) out of the pump body (13). On VA pump bodies, unscrew the spindle holder (25) with a SW13 open-end spanner, turning clockwise, and remove the entire unit.

– Remove the old O-ring from the spindle.

– Moisten a new O-ring with suitable O-ring grease (e.g. Fluoronox S90/2) and carefully attach it to the spindle.

– Carefully reinsert the entire unit into the pump body, turning, and tighten the bolts or spindle holder.

– Check the sample gas pump for leaks.

### 6.4 Changing the Coupling

**Please refer to assembly drawing 42/025-Z02-02-2 in the appendix for this maintenance.**

If the coupling breaks, always investigate the cause! If caused by e.g. a frozen bearing, replace the entire head.

– Remove the pump head and motor with coupling flange.

– Remove the coupling flange from the motor.

– After removing the set screw, remove the coupling parts from the shafts and attach a new coupling.

– Screw the coupling flange back onto the motor and install the pump the same as during initial installation.



## 7 Service and repair

This chapter contains information on troubleshooting and correction should an error occur during operation. Repairs to the unit must be performed by JCT authorised personnel.

Please contact our Service Department with any questions:  
P +43 2622 87201 or [service@jct.at](mailto:service@jct.at)

If the equipment is not functioning properly after correcting any malfunctions and switching on the power, it must be inspected by the manufacturer. Please send the equipment using our online RMA form and follow the on screen instructions.

[www.jct-gs.com/en/rma](http://www.jct-gs.com/en/rma)

## 7.1 Troubleshooting and fault rectification

### CAUTION

#### Risk due to defective device



Personal injury or damage to property

- a) Switch off the device and disconnect it from the mains.
- b) Repair the fault immediately. The device should not be turned on again before elimination of the failure.



### CAUTION

#### Hot surface



Burning hazard

According to the product type and operation conditions, the temperature of the housing may exceed 50 °C during operation. Depending on the conditions at the installation site it may be necessary to provide these areas with appropriate warning signs.

Malfunction	Cause	Action
Pump doesn't start up	– Broken or incorrectly connected lead	– Check connection or fuse and switch
	– Defective motor	– Replace motor
Pump doesn't convey	– Defective or dirty valves	– Carefully blow out or replace valves or see chapter 'Replacing inlet and outlet valves'.
	– Bypass valve open – Close bypass valve	
	– Defective bypass valve O-ring	– have repaired by a JCT service technician or see 'Replacing the bypass valve O-ring'
	– Torn bellow	– have repaired by JCT service technician or see Replacing the bellows and cam follower-eccentric combination.
Noisy pump operation	– Broken/worn ring gear	– have repaired by a JCT service technician or 'Replacing the coupling'
	– Crankshaft out of alignment	– have repaired by JCT service technician or see 'Replacing the bellows and cam follower-eccentric combination'
	– Work ring gear	– have repaired by a JCT service technician or 'Replacing the coupling'
Premature ring gear wear	– Loose coupling hub	– have repaired by a JCT service technician or tighten the stud on the coupling hub to 1.34 Nm
	– Engine bracket damaged	– Replace motor
	– e.g. contact with ozone influences or similar causing a physical change to the ring gear	– Eliminate any physical changes to the ring gear
Protective device is triggering	– Coil- and terminal short circuit	– Measure insulation resistance
	– Start-up time exceeded	– Check start-up requirements
Poor performance	– Leakage	– Tighten head screws, note torque (see chapter 'Maintenance')
	– Torn bellow	– have repaired by JCT service technician or see 'Replacing the bellows and cam follower-eccentric combination'
	– Defective or dirty valves	– Carefully blow out or replace valves or see chapter 'Replacing inlet and outlet valves'

Tab. 1: Troubleshooting

## 7.2 Spare parts and accessories

Please also specify the model and serial number when ordering parts. Upgrade and expansion parts can be found in our catalog.

Available spare parts:

<b>Spare part</b>	<b>Item no.</b>	<b>Position in assembly drawings</b> <b>42/025-Z02-01-2 &amp; 42/025-Z02-02-2</b>	
JSP-200	Bellow	85.97101	12a
	Plunger / eccentric combination	85.97102	10a, 11
	Set of 160 °C valves	85.97103	2x 17b
	Bypass O-ring	85.97104	21a

Tab. 2: Spare Parts and Accessories

<b>Part No.</b>	<b>Spare Parts</b>
85.97101	Bellow PTFE for sample gas pump JSP-200
85.97102	Spare part 608 for sample gas pump JSP-200
85.97103	Valve set for sample gas pump JSP-200 160 °C
85.97104	O-ring for sample gas pump JSP-200 bypass valve 80 °C

## 8 Disposal

Dispose of parts so as not to endanger the health or environment. Follow the laws in the country of use for disposing of electronic components and devices during disposal.

## 9 Appendices

### 9.1 General specifications for all pumps

#### General Specifications

Nominal voltage:	see ordering information
Protection class:	electric IP55
	mechanical IP20
Dead volume:	8.5 ml
Materials of parts in contact with mediums by pump type:	PTFE / PVDF (standard pump with 100 °C valves) + PEEK (standard pump with 160 °C valves)

### 9.2 Feed Curves

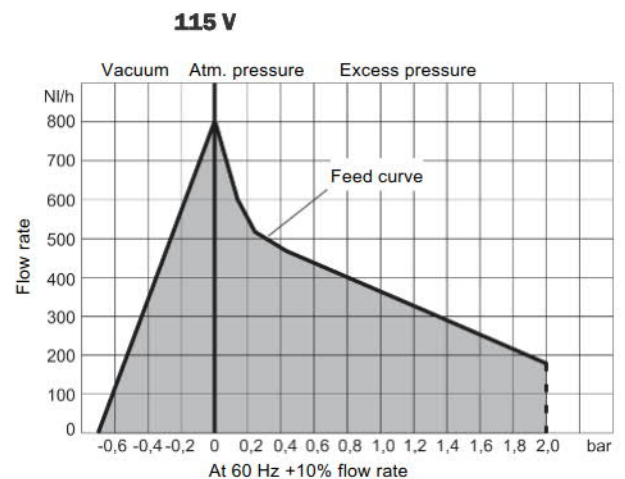
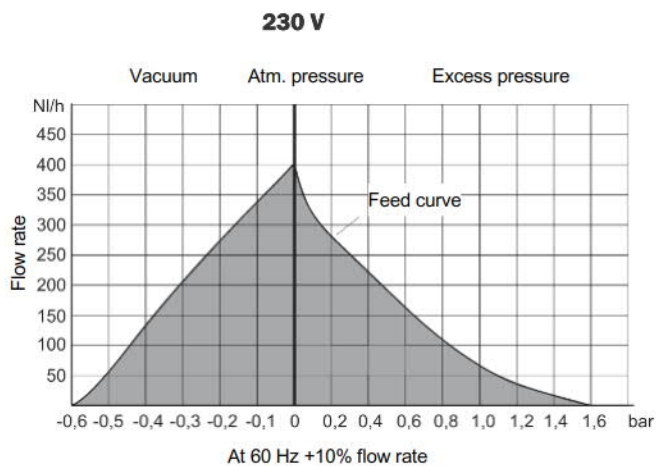

### 9.3 Technical data

#### Technical Data

Weight:	approx. 6.5 kg
FM C-US (115 V only)	
FM approval no.:	3038101/3038101C
Ambient temperature:	max. 60 °C
Medium temperature:	PTFE/PVDF valves max. 100 °C PTFE/PEEK valves max. 160 °C

## 9.4 Dimensions

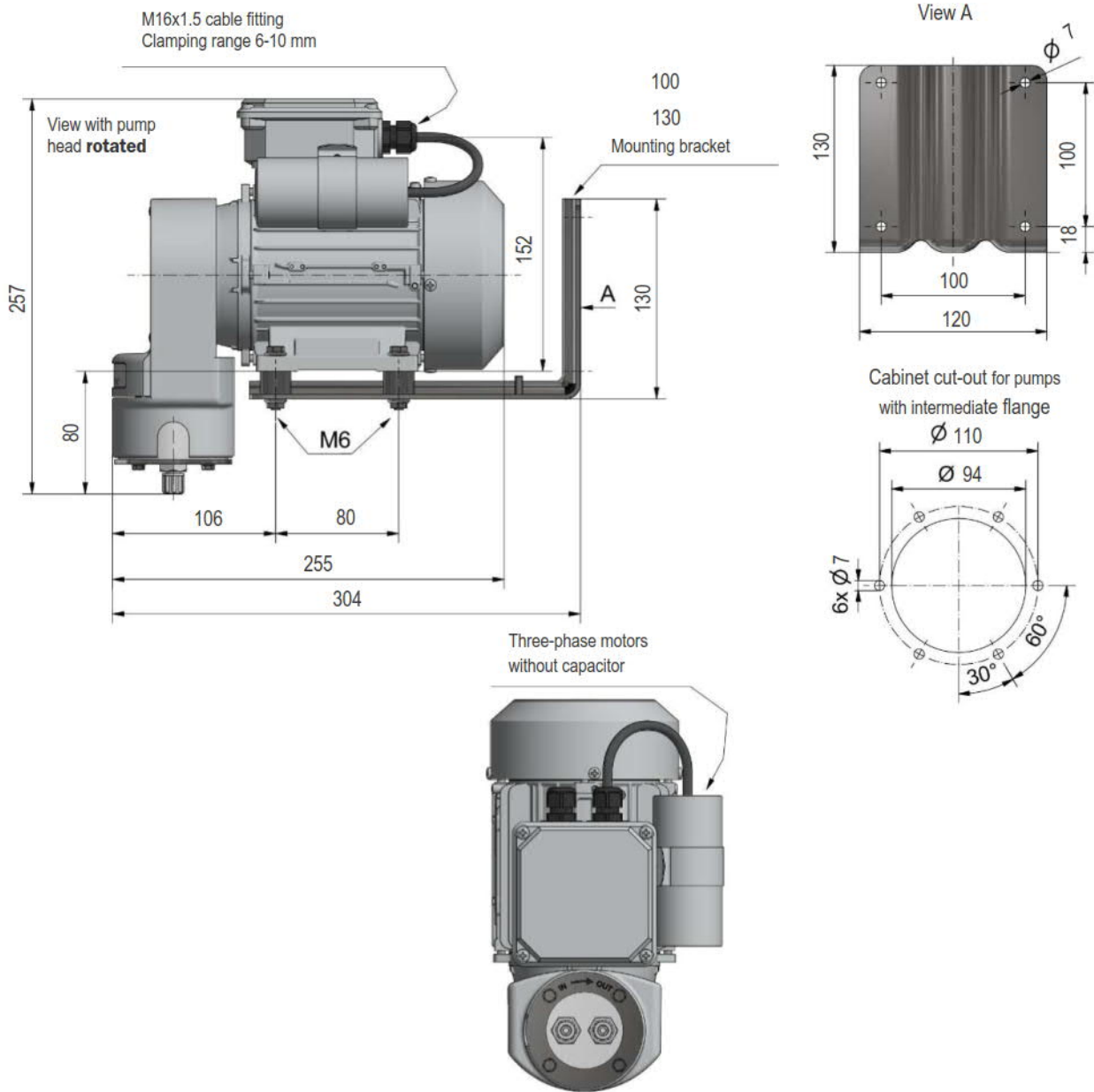

### Installation notices:

- 1) This pump should be installed horizontally
- 2) If necessary, rotate the pump head during installation. When conveying gasses with condensate content it must be installed valves down

## 9.5 Order codes

Part No.	Sampling Pipe
85.07101	JSP-200 Sample gas pump with bypass valve 230 V
85.07102	JSP-200 Sample gas pump with bypass valve 115 V FM C-US

## 10 Attached documents

- Drawings: 42/025-Z02-01-2; 42/025-Z02-02-2; 42/025-Z02-03-2
- Operating instructions

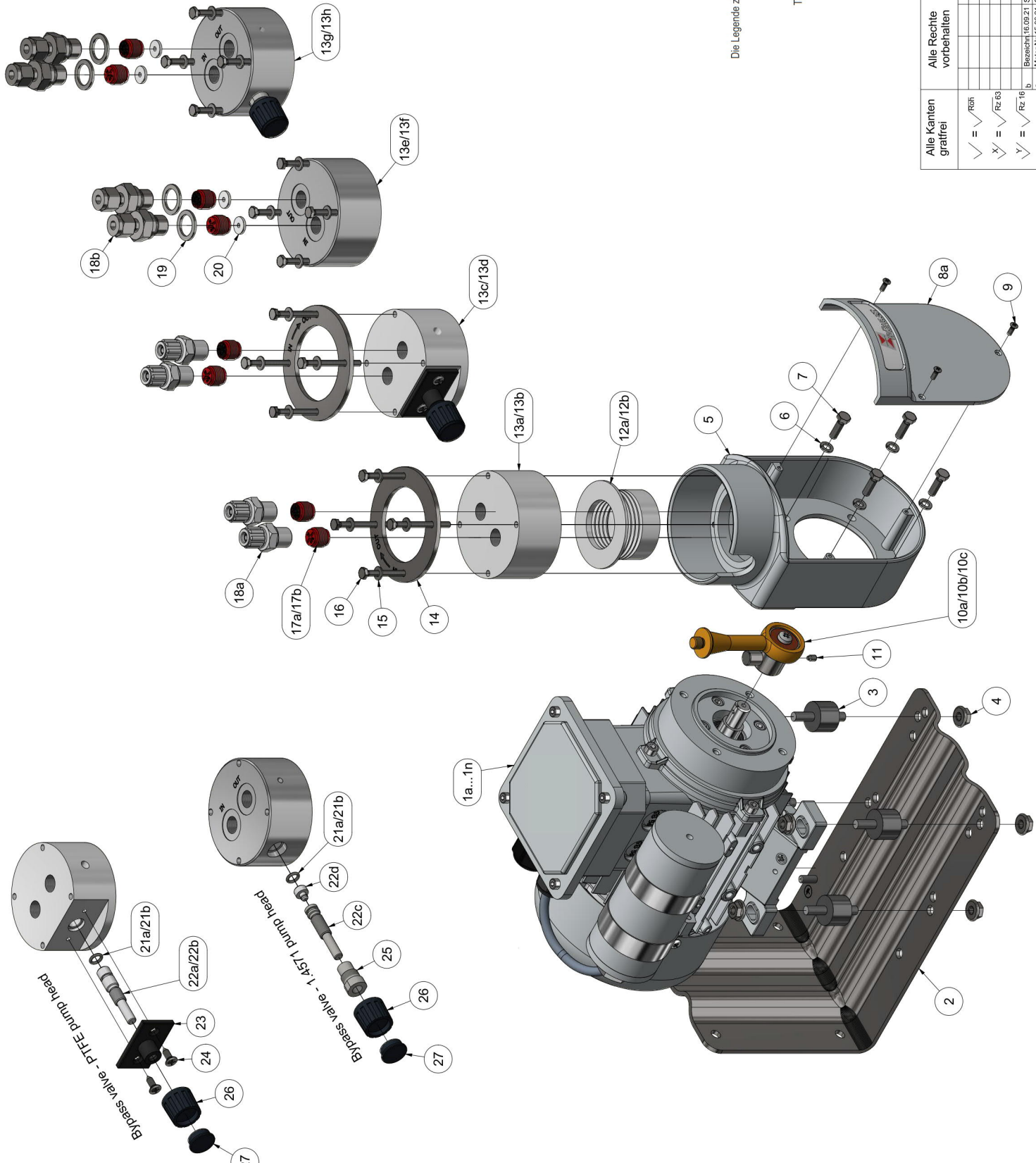

Die Legende zu den Positionsnummierungen dieser Zeichnung, sowie deren spezifische Zuordnung zu den unterschiedlichen Pumpentypen befindet sich auf der Zeichnung 42/025-Z02-03-2.

The legend for the item numbers in this drawing and their specific assignment to the different pump types can be found on drawing 42/025-Z02-03-2.

Alle Kanten gratfrei	Alle Rechte vorbehalten	Maße ohne Toleranzangabe nach ISO 2768-mK	Maßstab: 1:1,75	Masse:
✓ = √ R0h ✓/ = √ Rz 63 ✓/ = √ Rz 16 ✓/ = √ Rz 4	✓ = √ R0h ✓/ = √ Rz 63 ✓/ = √ Rz 16 ✓/ = √ Rz 4	Datum: 03.02.2021 Beib: 03.02.2021 Gepr.:	Werkstoff: Benennung: Montagezeichnung - JSP-200	ZeichnungsNr.: 42/025-Z02-01-2B Art.Nr.: ---- Arbeitsweisung:
Beseitigt 16.09.21 Sun Motor Nr 15.06.21 Sun Ztbl. And. Datum Name/Ers.für:		JSP Hydraulische GmbH www.jsp.at AUSTRIA		



Legende und spezifische Zuordnung der Positionsnummern aus den Montagezeichnungen  
 Legend and specific assignment for the item numbers of the assembly drawings

42/025-Z02-01-2

Zeichnungsnummer/Drawing no. 42/025-Z02-03-2   Rev.B   Date: 16.09.2021   Autor: Sundergeld		
Änderung: B = P4 Motoren hinzugefügt   Geprüft am:   Prüfer:		
Pos. No.	Description	Beschreibung
1a	Motor 230V 50/60Hz	Motor 230V 50/60Hz
1b	Motor 115V 50/60Hz	Motor 115V 50/60Hz
1c	Motor 230/400V 50/60Hz	Motor 230/400V 50/60Hz
2	Montagekonsole	Mounting bracket
3	Gummi-Metall-Puffer	Shock absorber
4	Mutter DIN 6923 - M6	Nut DIN 6923 - M6
5	Pumpenkonsole	Pump housing
6	Federring DIN 127 B5,1	Spring washer DIN 127 B5,1
7	Schraube DIN 933 M5x16	Screw DIN 933 M5x16
8a	Konsolendeckel - standard	Cover - standard
9	Schraube DIN 966 M3x8	Screw DIN 966 M3x8
10a	Kurbeltrieb für 400l/h Pumpen (Stößel gold)	Crank drive for 400l/h pumps (plunger gold)
11	Schraube DIN 915 M4x6 oder ISO 4028 M4X6 TX 8	Screw DIN 915 M4x6 or ISO 4028 M4X6 TX 8
12a	Faltenbalg für 400l/h Pumpen (4 Falten)	Below for 400l/h pumps (4 folds)
13a	Pumpenkörper - PTFE für 400l/h Pumpen	Pump head - PTFE for 400l/h pumps
13c	Pumpenkörper - PTFE mit Bypassventil für 400l/h Pumpen	Pump head - PTFE with bypass valve for 400l/h pumps
13e	Pumpenkörper - 1.4571 für 400l/h und 700l/h Pumpen	Pump head - 1.4571 for 400l/h and 700l/h pumps
13g	Pumpenkörper - 1.4571 mit Bypassventil für 400l/h und 700l/h Pumpen	Pump head - 1.4571 with bypass valve for 400l/h and 700l/h pumps
14	Montagering - nur für PTFE Pumpenkörper	Mounting ring - only for pump heads made of PTFE
15	Spannscheibe DIN 6796 d=4	Clamping washer DIN 6796 d=4
16	Schraube DIN 933 M4x45	Screw DIN 933 M4x45
17a	Ventil - geeignet bis zu 100°C Gaseingangstemperatur	Valve - suitable up to 100°C gas inlet temperature
17b	Ventil - geeignet bis zu 160°C Gaseingangstemperatur	Valve - suitable up to 160°C gas inlet temperature
18a	Kunststoff Einschraubverschraubung - diverse Typen - siehe Pumpendatenblätter	Plastic fitting - various types - see pump data sheets
18b	Edelstahl Rohrverschraubung - diverse Typen - siehe Pumpendatenblätter	Stainless steel fitting - various types - see pump data sheets
19	Dichtring - nur für Edelstahl Pumpenkörper	Sealing ring - only for pump heads made of 1.4571
20	Verdränger - nur für Edelstahl Pumpenkörper	Displacer - only for pump heads made of 1.4571
21a	O-Ring - FKM	O-Ring made of FKM
21b	O-Ring - FFKM	O-Ring made of FFKM
22a	Spindel für Bypassventil - geeignet bis zu 100°C Gaseingangstemperatur	Spindle for PTFE bypass valve - suitable up to 100°C gas inlet temperature
22c	Spindel für Edelstahl Bypassventil	Spindle for 1.4571 bypass valve
22d	Spindelspitze	Spindle tip
23	Montageplatte Bypassventil	Mounting plate bypass valve
24	Schraube DIN 7982 4,2x13	Screw DIN 7982 4,2x13
25	Spindelaufnahme	Spindle holder
26	Drehknopf	Knob
27	Deckel	Cover
X	Kompletter Pumpenkopf - diverse Kombinationsmöglichkeiten	Complete pump head - various combinations



# Service instructions

## Safety prescriptions

Via Mantova, 93 43122 Parma  
☎ +39-0521-272383 ☎ +39-0521-272686

(Issued 2019/01/19)

## Indications on safety prescriptions and special instructions for three phase and single phase motors

These symbols will draw your attention to the safety measures and additional instructions given in these Operating Instructions.

Special instructions regarding safety and warranty



Danger

For reasons of protection of persons and objects strictly follow the safety measures and additional instructions given in these Operating Instructions.

⚠ Electric rotating machines present dangers from live and rotating parts, and probably very hot surfaces. All work on them including transportation, connection, commissioning and maintenance must be by qualified and responsible specialists (IEC 364 must be observed). Inadequate work can lead to severe damage to persons and property.

⚠ All work on electrical connections to the motors must be performed only by qualified personnel.

## SPECIFIED USE AND WORKING CONDITIONS

These low voltage motors are only intended for use in industrial plants and are in accordance with the relevant sections of EN 60034/IEC34. Their use in hazardous areas is prohibited, unless explicitly indicated. The motors are suitable for ambient temperatures from -20°C (68°F) to +40°C (104°F) and altitudes <= 1000m above sea level.

⚠ It is imperative to observe the data printed on the nameplate before operating the motor. Low voltage motors are components to be installed into machines in accordance with Directive 2006/42/EC. Commissioning is not allowed until the conformity of the end product with this document is verified. These asynchronous motors comply with EN 50081 and EN 50082 standards on electromagnetic compatibility for the EMC (2004/108/EC) Directive and no particular shielding is necessary when connected to a pure sinewave voltage supply.

⚠ Before working on the motor, ensure it has stopped and is disconnected from the power supply (including auxiliary equipment). If there is any form of automatic starting, automatic resetting, relays or remote starting, avoid any possibility of unexpected re-starting, paying attention to specific recommendations on equipment application.

⚠ In single phase motors, capacitors can remain temporarily charged resulting in live terminals even after the motor has stopped. Discharge all the capacitors and ground every terminal before touching any connection.

## TRANSPORT STORAGE

On receipt verify that the motor has not been damaged during transport and in this case avoid any installation and communicate immediately to the transport service.

⚠ Eyebolts, when provided with the motor, must be tightened properly as they are suitable only for lifting the motor, no additional loads are allowed to be attached. If necessary, use sufficiently dimensioned devices as a means of transport. Do not use any projection of the motor body to hang the motor for transport purposes.

⚠ If two eyebolts are present on the motor use both for lifting. Store low voltage motors in a dry, dust free and low vibration (v eff <0.2 mm/s) area to prevent bearing damage. Before commissioning, the insulation resistance must be measured. In case of values < 1.5 MΩ the winding must be dried. Contact our technical department directly for information on the drying procedure.

## INSTALLATION

⚠ All work must only be done by qualified personnel with the low voltage motor and driven machine at standstill, electrically dead and locked against restart. The rotor has been balanced dynamically with a half key fitted. The coupling components must also be balanced with a half key on a smooth inertial. Coupling bolts and pulleys must be assembled by suitable tools to protect the bearings. Balls and pulleys must be assembled by suitable tools to protect the bearings.

After assembly check that the coupling components are well fixed on the shaft end; they must be properly pushed against the shaft shoulder. Where the hub of the coupling gear is shorter than the shaft end, compensate the difference by use of a bush spacer. Too large or too small pulleys can impair the shaft bearing life; similarly excessive belt tension can cause low bearing life or shaft breakage.

The motors must be installed in a proper position so that cooling air can go in and out easily. The ventilation must not be hindered and the outgoing air - also from adjacent units - must not be directly sucked in again.

Avoid heat sources near the motor that might affect the temperatures both of cooling air and of the motor. In case of outdoor installation protect the motor from solar radiation and extremes of weather.

It is advisable to protect the motor with such as over-current devices and torque limiters where it is not protected by winding temperature transducers connected to appropriate switchgear.

In case of environments with wide thermal excursions and when can be preview the presence of moisture, the motor must be equipped with heaters, drain holes must be positioned in places dependent on the installation configuration.

⚠ In case of installation of motors with face flange B14, make sure that the fixing screws of a proper length compared to the support diameter to avoid some could damage the motor winding. In case of support provided with screws and O-ring seals, such seals shall be replaced in the right position during the assembling.

⚠ Check the direction of rotation with the motor not coupled fastening the shaft key to avoid its violent ejection during rotation.

If the direction of rotation is not as desired, disconnect the motor and wait until the motor is completely stopped:

- in the case of three phase motors interchange two phases at the terminals

- in the case of single phase motors refer to the diagram supplied with the motor

⚠ Connection must be made in such a way that a durably safe, electrical connection is maintained: adequate cable and associated equipment must be used.

⚠ Metallic parts that are normally not energized must be connected to earth by means of green-yellow cable of a proper section using the earth terminal inside the terminal box.

The terminal box must be free of foreign bodies, dirt and humidity. Open cable gland holes must be sealed. Use appropriate cable glands if these are not included with the motor. Check if the cable diameter is compatible with the cable gland installed. Always close the terminal box cover in order not to invalidate the protection class of the motor.

## CONNECTION

⚠ The electrical connection must be done by qualified personnel in accordance with appropriate regulations such as IEE, EN 60204 and local prescriptions.

⚠ Always refer to the data printed on the nameplate for voltage and frequency to ensure the motor is appropriate for the mains supply.

If not specified it is possible to assume tolerances of ±5% on voltage and ±1% on frequency indicated on the nameplate.

The connection diagrams are normally supplied together with the motor or are printed in the terminal box. If they are missing please refer to this manual or contact directly to our technical office. Check and make sure that, in the case of star /delta start, the switching from star to delta can only be executed after the starting current of the star step has fallen; this is important because of the risk of not permitted operational loads.

In case the motor is provided with thermal protector connect the thermal protector cables to a auxiliary contact following the drawing:

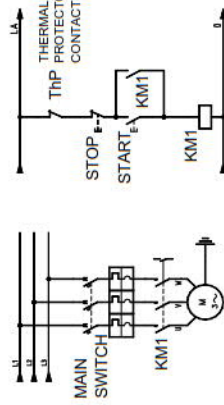

**MAINTENANCE:**  
If necessary and periodically (depending on the environment and duty) verify and maintain as necessary to ensure:  
- motor cleanliness (oil, dirt and machining residuals absence) and free passage of cooling air  
- correct tightening of electrical connections, of fastening screws  
- free motor (15KW) and absence of pronounced noises; where there is high vibration and/or noise verify the motor fastenings, machine balancing and that the bearings are in good condition.

FAULT	Possible causes	Remedy
Bearing too hot		
Bearing noise		
Motor runs unevenly		
	Pulley tension too high	Reduce pulley tension
	Coupling forces are pulling or pushing	Realign motor, correct coupling
	Coolant temperature above 40°C (104°F)	Adjust temperature of cooling air
	Motor incorrectly mounted	Correct the motor mounting
	Unbalance caused by pulley or coupling	Balance finely
	Motor fastening insecure	Improve fastening
	Motor fastening insecure	Improve fastening
	<b>If the remedies described here are insufficient, we recommend replacement of the bearings</b>	

FAULT	Protective devices	Possible causes	Remedy
Doesn't start			
Too hot			
Speed reduction			
		Resisting torque is too high	Reduce the load torque
		Mains voltage too low	Increase mains voltage
		Phase interruption	Check mains supply
		Wrong connection	Check with the wiring diagram
		Overload	compare data on rating plate with measurements
		Switching frequency too high	Observe rated duty type
		Insufficient ventilation	Check ventilation passages
		Short circuit of winding or terminal board	Measure insulation resistance
		Starting time exceeded	Reduce load torque/load inertia

